

uitwerkbijlage

Naam kandidaat _____ Kandidaatnummer _____

1

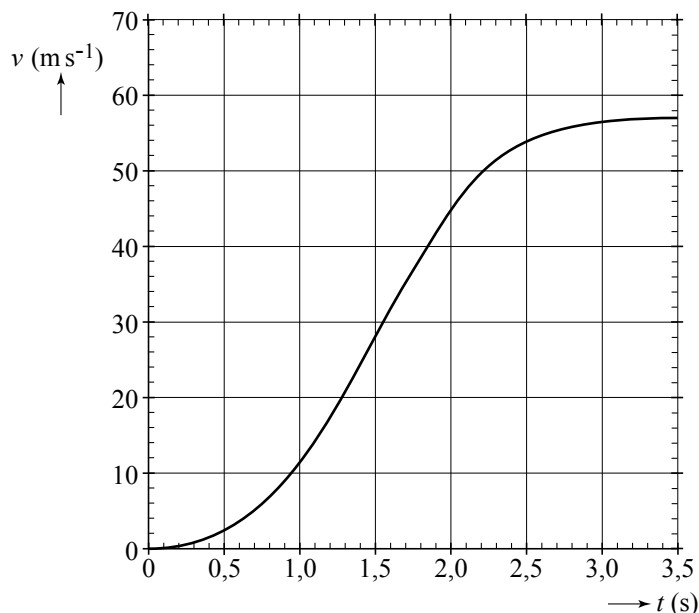

Toelichting:

.....

.....

4

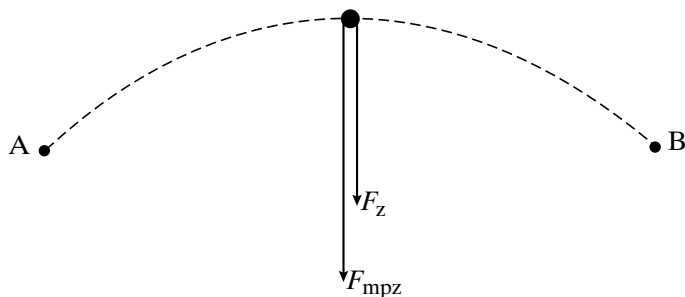

Naam van de kracht:

5



7

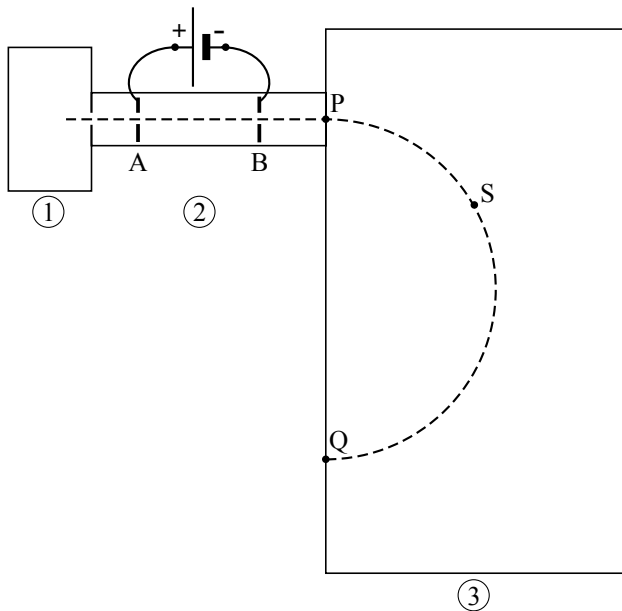

15 eerste figuur:

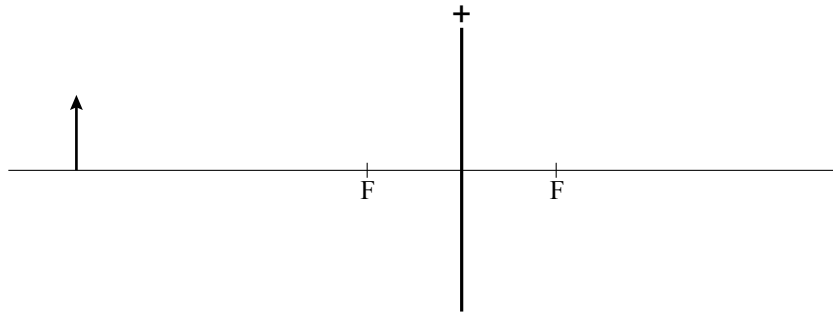

tweede figuur:

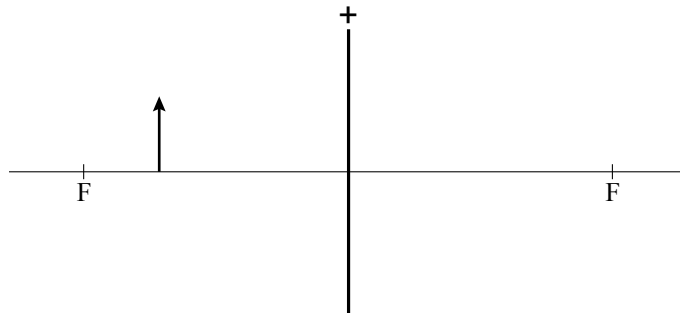

Uitleg:

.....

.....

.....

20

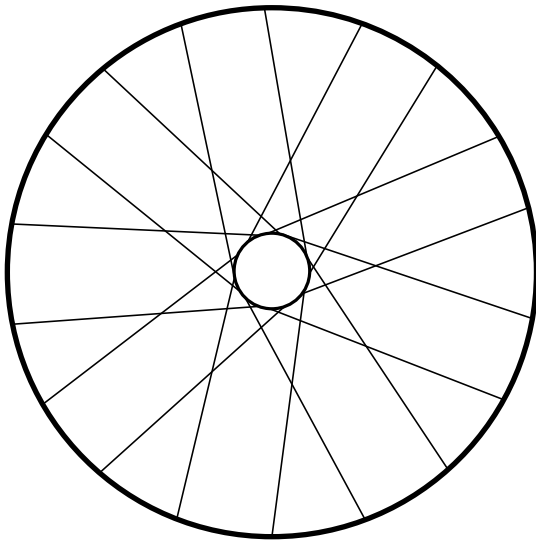

21

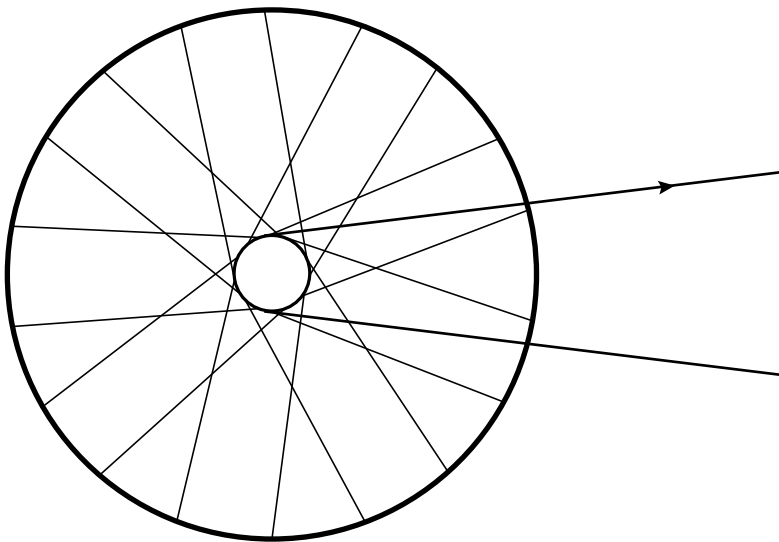

22

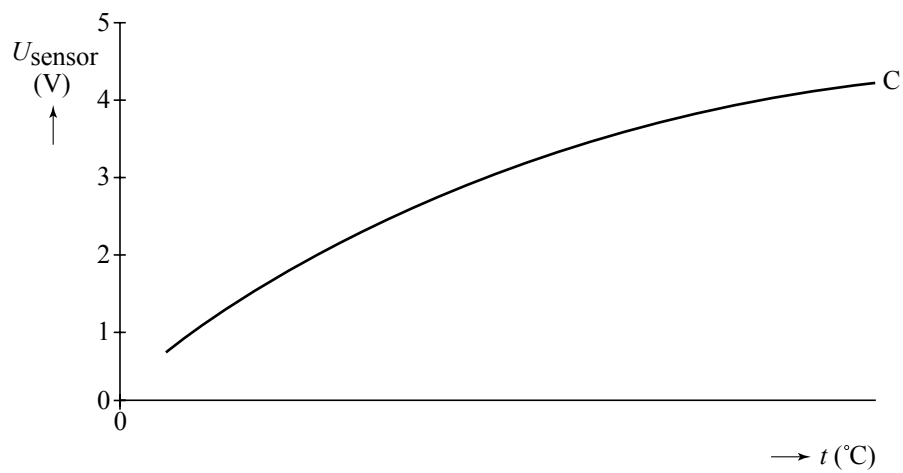

VERGEET NIET DEZE UITWERKBIJLAGE IN TE LEVEREN